

IPH High-pressure internal gear pumps Technical data sheet

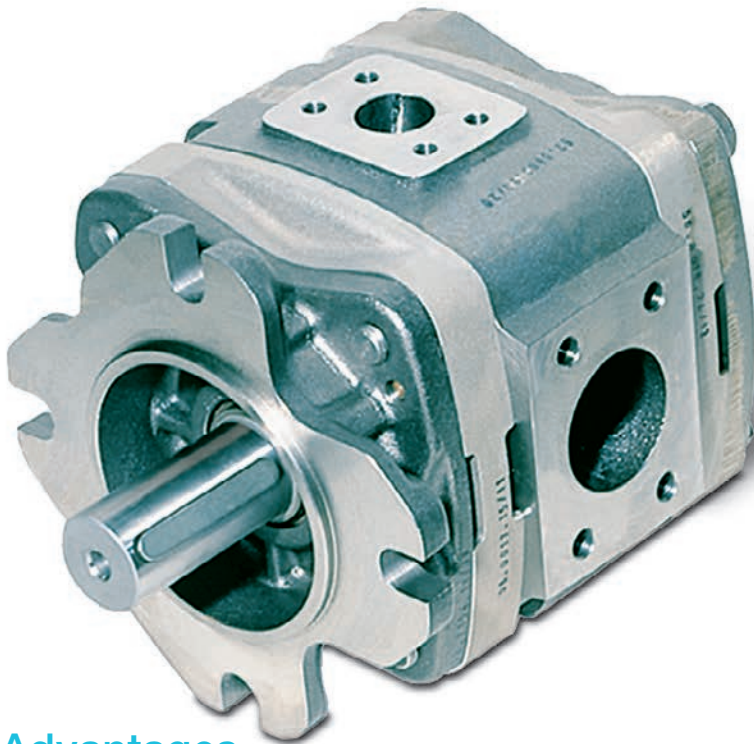

Advantages

- + High volumetric and overall efficiency
- + Very good pulsation behavior
- + Robust and compact
- + Low noise emission
- + Multiple flow capable

Design and function

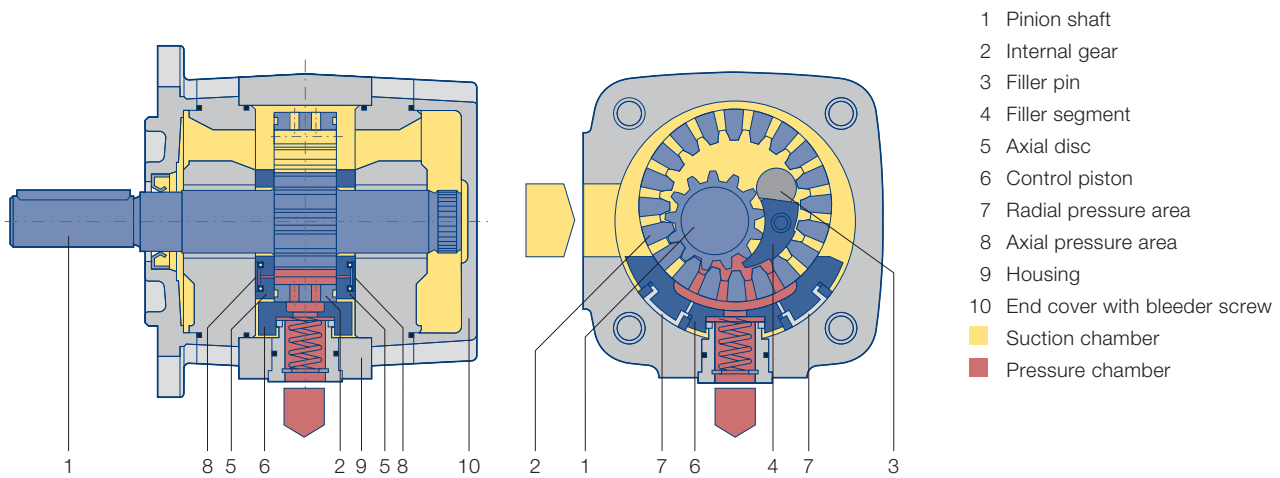

Function

Rotation of the gears within the pump draws in the pressure fluid (usually hydraulic oil) into the space between the pinion and internal gear. The two smooth running gears help to ensure excellent intake behavior.

In the radial direction, the gear chambers are sealed by gear meshing and the filler piece. In the axial direction, the axial plates seal the pressure chamber with the minimal possible gap. This design minimizes volume losses and increases efficiency. When the gears rotate, the pinion teeth enter the gaps between the internal gear teeth and displace the pressure fluid.

Calculations

Pump flow $Q = V_{g\text{th}} \cdot n \cdot \eta_v \cdot 10^{-3} \text{ [l/min]}$

Power $P = \frac{Q \cdot \Delta p}{600 \cdot \eta_g} \text{ [kW]}$

$V_{g\text{th}}$	pump volume per revolution [cm ³]
n	Speed [rpm]
η_v	Volumetric efficiency
η_g	Overall efficiency
Δp	Differential pressure [bar]

Technical data

Design	Internal gear pump with radial and axial sealing gap compensation
Type	IPH
Mounting types	SAE-hole flange; ISO 3019/1
Line mounting	SAE suction and pressure flange J 518 C Code 61
Sense of rotation	right or left-hand rotation
Mounting position	any
Shaft load	for details of radial and axial drive shaft loads please contact J.M. Voith SE & Co. KG
Input pressure	0.8...3 bar absolute pressure (at start up for short time 0.6 bar)
Pressure fluid	HLP mineral oils DIN 51524. part 2 or 3
Viscosity range	10 ... 300 mm ² s ⁻¹ (cSt)
Permissible start viscosity	max. 2000 mm ² s ⁻¹ (cSt)
Permissible temperature of the pressure fluid	-20 ... +80 °C
Required purity of the pressure fluid	Class 8 (NAS 1638)
Filtration	filtration quotient min. $\beta_{20} \geq 75$, recommended $\beta_{10} \geq 100$ (longer life)
Permissible ambient temperature	-10 ... +60 °C

Characteristics

Type. size – delivery	Displacement per revolution [cm ³]	Speed min. [min ⁻¹]	Speed max. [min ⁻¹]	Delivery at 1500 rpm [l/min]	Continuous pressure [bar]	Peak pressure [bar]
IPH 4 – 20	20.7	300	3000	31.0	300	330
IPH 4 – 25	25.7	300	3000	38.6	250	315
IPH 4 – 32	32.3	300	3000	48.5	250	300
IPH 5 – 40	40.8	300	3000	61.2	300	330
IPH 5 – 50	50.3	300	3000	75.4	250	315
IPH 5 – 64	63.9	300	3000	95.8	250	300
IPH 6 – 80	81.3	300	2500	121.9	300	330
IPH 6 – 100	101.6	300	2500	152.4	250	315
IPH 6 – 125	125.6	300	2500	188.8	250	300

The values given apply for

- Pumping of mineral oils with a viscosity of 20 ... 40 mm²s⁻¹
- An input pressure of 0.8...3.0 bar absolute

Notes

- Peak pressures apply for 15 % of operating time with a maximum cycle time of 1 minute
- Please inquire about peak pressures at non-standard speeds
- Due to production tolerances. the pump volume may be reduced by up to 1.5 %.

IPH Size 4, Rotation and dimensions

Rotation clockwise (cw)

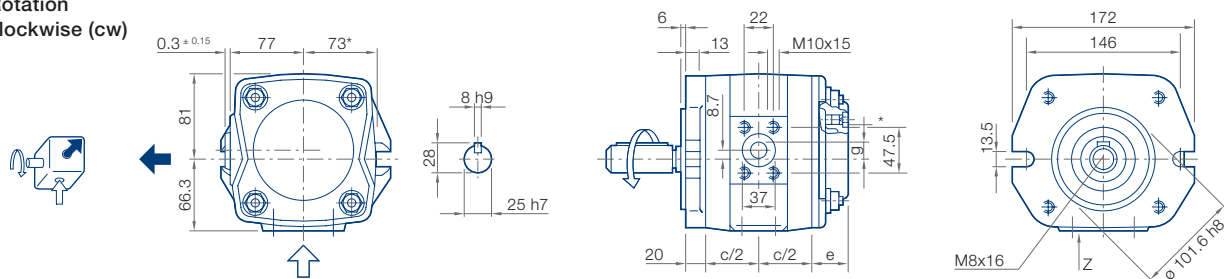

Rotation counter-clockwise (ccw)

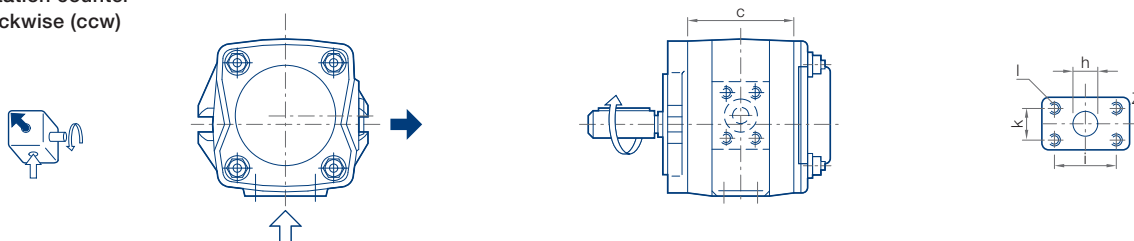

Type/ Delivery	c [mm]	e [mm]	g [mm]	h [mm]	i [mm]	k [mm]	l Thread	Weight [kg]	SAE Flange No. ↑ ↓
IPH 4 – 20	102	36	19	30	58.7	30.2	M10x15	13.5	11 13
IPH 4 – 25	108	36	21	30	58.7	30.2	M10x15	14.2	11 13
IPH 4 – 32	116	36	24	32	58.7	30.2	M10x15	15.0	11 13

* Ensure the M10x1 plug screw, hexagon socket SW5, is tightened to a torque of 10 Nm during pumping operation.
Dependent on the pump position, filling or ventilation is possible here prior to commissioning.

IPH Size 4, Designs and dimensions

Rotation, Suction port

Mounting flange

Shaft end

Standard

Rotation clockwise,
radial suction port



SAE 2-hole flange

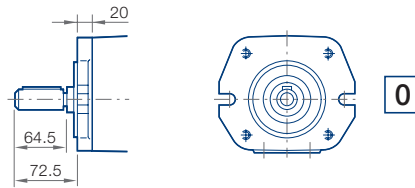

Keyway connection

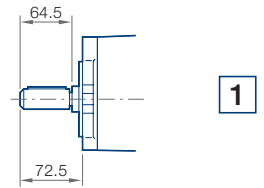

Variants

Rotation counterclockwise,
radial suction port

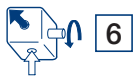

Involute gearing with
SAE-2-hole-flange

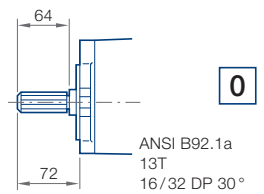

SAE 4-hole flange

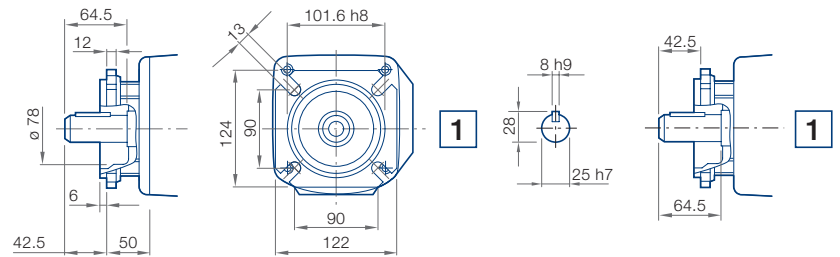

Involute gearing with
SAE-4-hole-flange

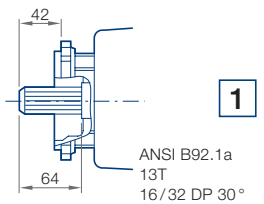

* Direction of rotation free selectable in the illustrated mounting flange/shaft end combination.

IPH Size 5, Rotation and dimensions

Rotation clockwise (cw)

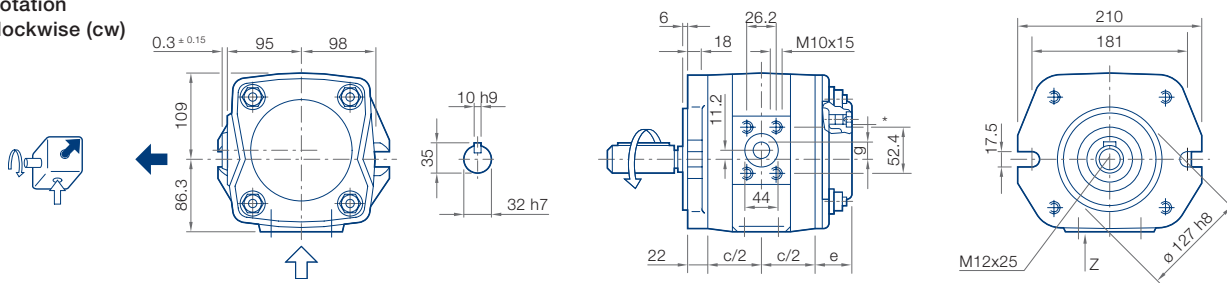

Rotation counter-clockwise (ccw)

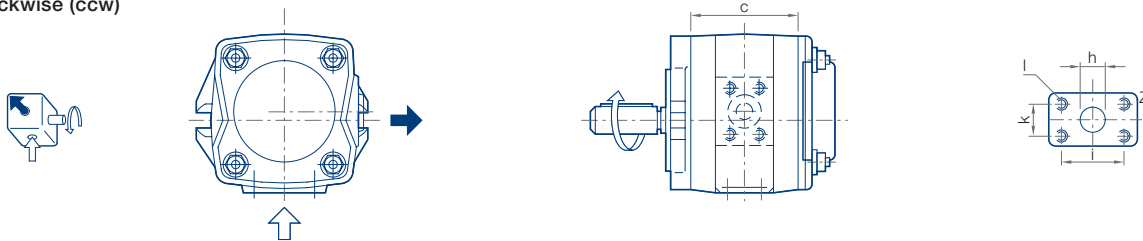

Type/ Delivery	c [mm]	e [mm]	g [mm]	h [mm]	i [mm]	k [mm]	l Thread	Weight [kg]	SAE Flange No. ↑ ↓
IPH 5 – 40	138	35	24	35	69.9	35.7	M12 x 19	26.8	12 30
IPH 5 – 50	145	35	27	42	69.9	35.7	M12 x 19	28.3	12 30
IPH 5 – 64	155	35	29	42	69.9	35.7	M12 x 19	30.0	12 30

* Ensure the M10x1 plug screw, hexagon socket SW5, is tightened to a torque of 10 Nm during pumping operation.
Dependent on the pump position, filling or ventilation is possible here prior to commissioning.

IPH Size 5, Designs and dimensions

Rotation, Suction port

Mounting flange

Shaft end

Standard

Rotation clockwise,
radial suction port

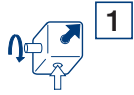

SAE 2-hole flange

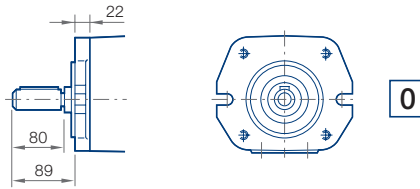

Keyway connection

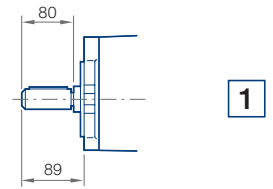

Variants

Rotation counterclockwise,
radial suction port

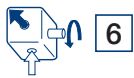

Involute gearing with
SAE-2-hole-flange

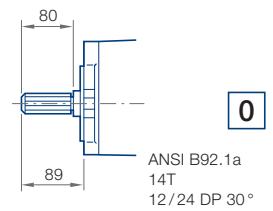

SAE 4-hole flange

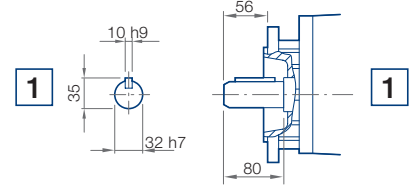
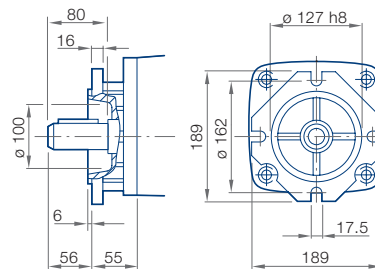

Involute gearing with
SAE-4-hole-flange

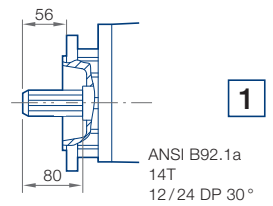

* Direction of rotation free selectable in the illustrated mounting flange/shaft end combination.

IPH Size 6, Rotation and dimensions

Rotation clockwise (cw)

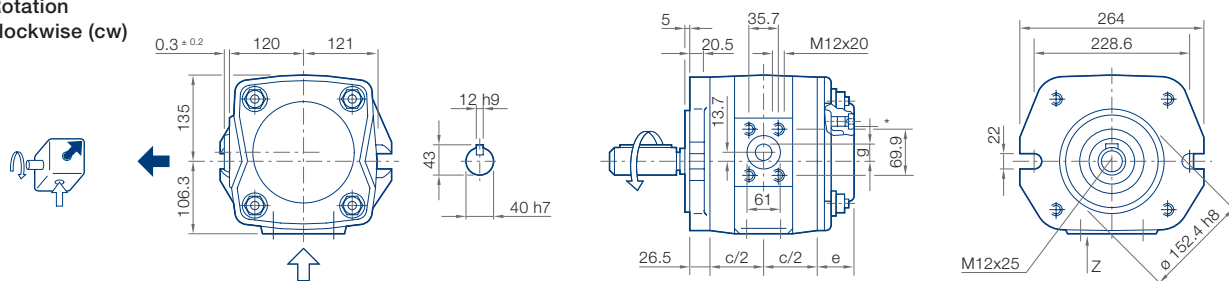

Rotation counter-clockwise (ccw)

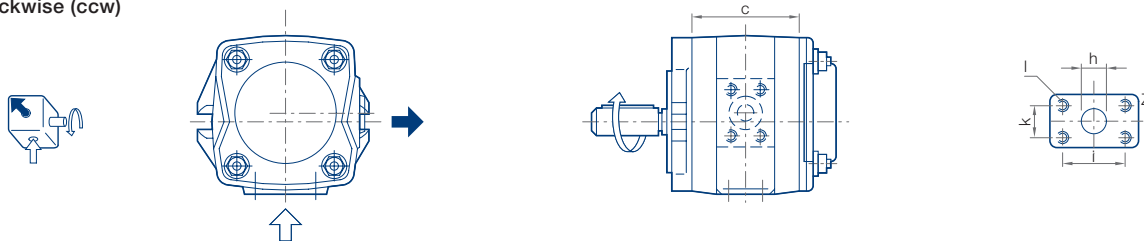

Type/ Delivery	c [mm]	e [mm]	g [mm]	h [mm]	i [mm]	k [mm]	l Thread	Weight [kg]	SAE Flange No.	
IPH 6 – 80	171	49	32.5	50	77.8	42.9	M12x23	50.5	14	15
IPH 6 – 100	181	49	36	50	77.8	42.9	M12x23	54.0	14	15
IPH 6 – 125	193	47	39	50	77.8	42.9	M12x23	58.0	14	15

* Ensure the M10x1 plug screw, hexagon socket SW5, is tightened to a torque of 10 Nm during pumping operation. Dependent on the pump position, filling or ventilation is possible here prior to commissioning.

IPH Size 6, Designs and dimensions

Rotation, Suction port

Mounting flange

Shaft end

Standard

Rotation clockwise,
radial suction port

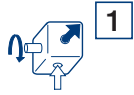

SAE 2-hole flange

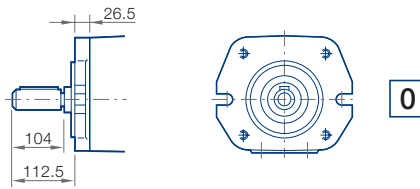

Keyway connection

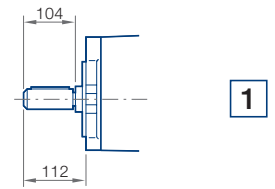

Variants

Rotation counterclockwise,
radial suction port

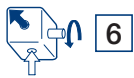

Involute gearing with
SAE-2-hole-flange

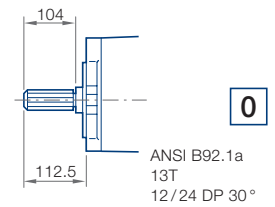

SAE 4-hole flange

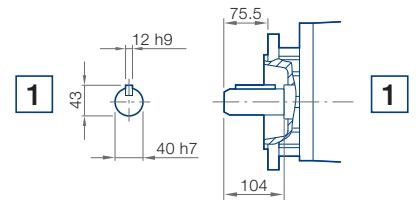
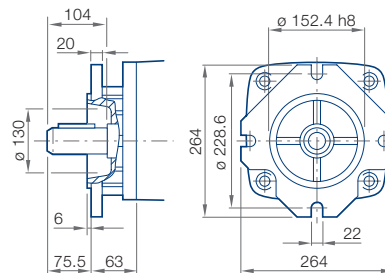

Involute gearing with
SAE-4-hole-flange

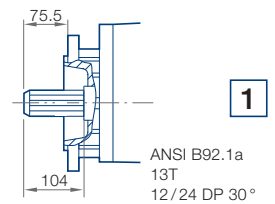

* Direction of rotation free selectable in the illustrated mounting flange/shaft end combination.

Measurement values – Airborne noise level

IPH 4

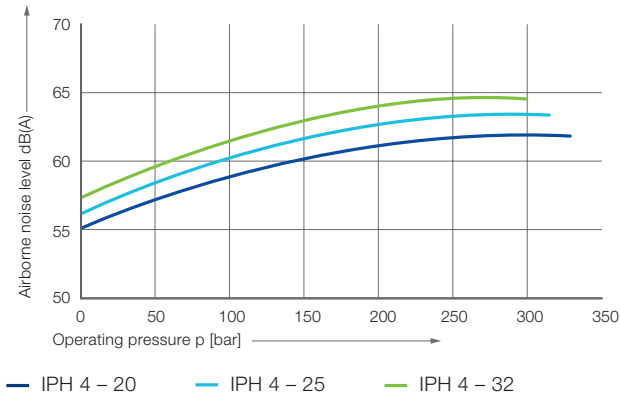

IPH 5

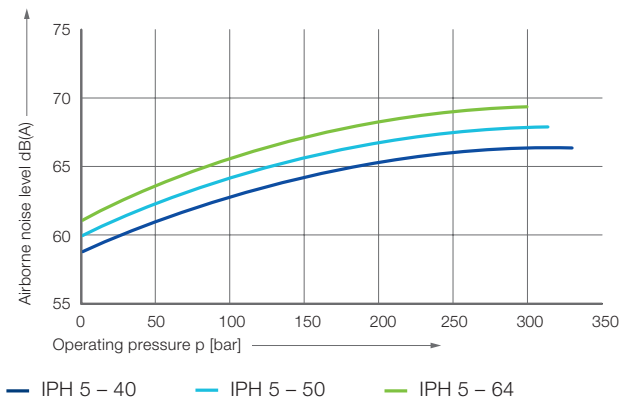

IPH 6

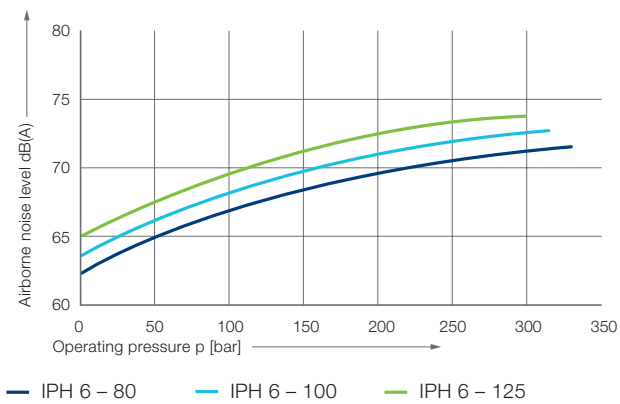

Measurement values – Efficiency η_v and η_g

IPH 4

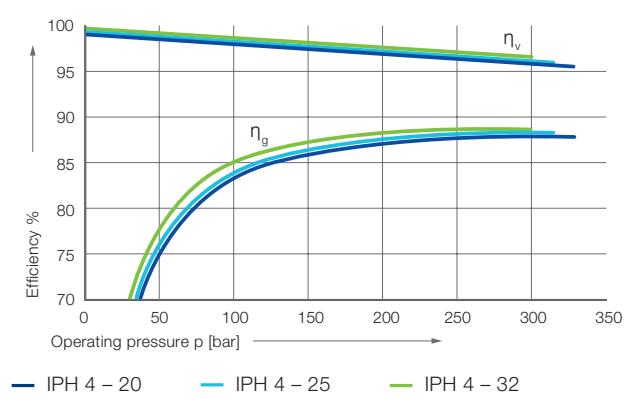

IPH 5

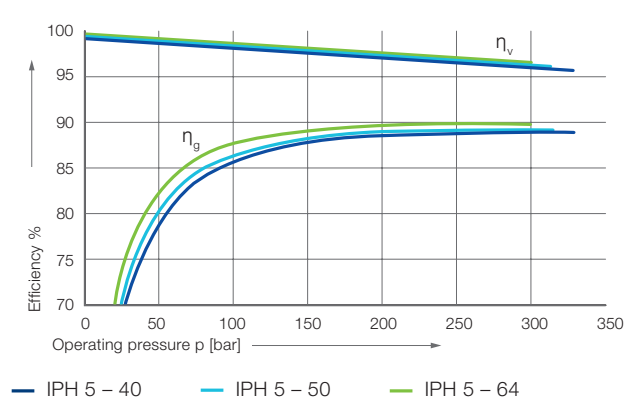

IPH 6

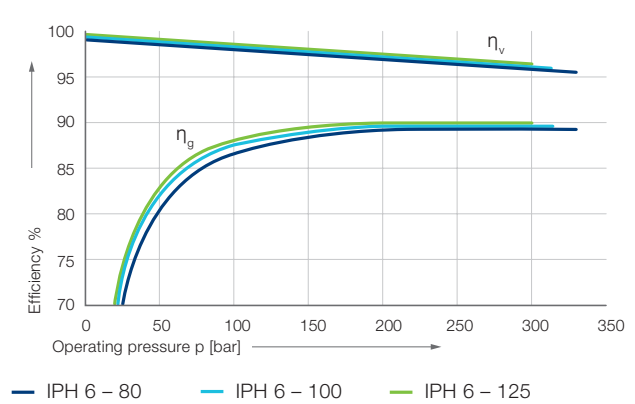

Measurement conditions

- Speed: 1 500 rpm
- Viscosity of pressure fluid: 46 mm²s⁻¹
- Operating temperature: 40 °C

Note

Measurement taken in a low-noise room. In a anechoic room the measurements are approx. 5 dB(A) lower.

Measurement values – Delivery Q

IPH 4

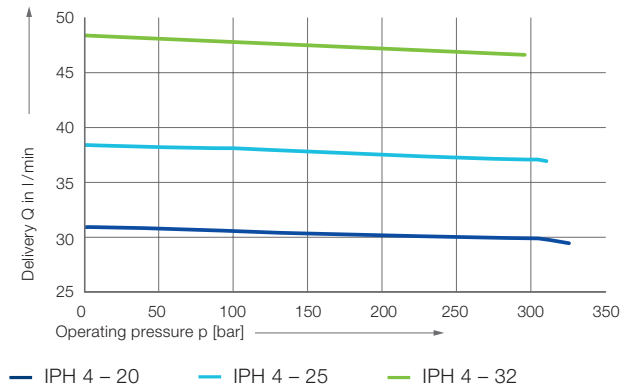

Measurement values – Input power P

IPH 4

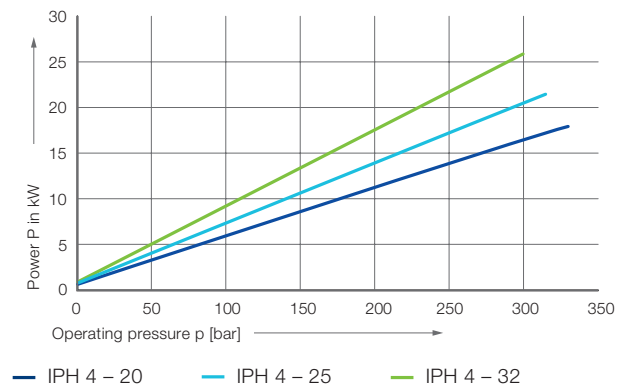

IPH 5

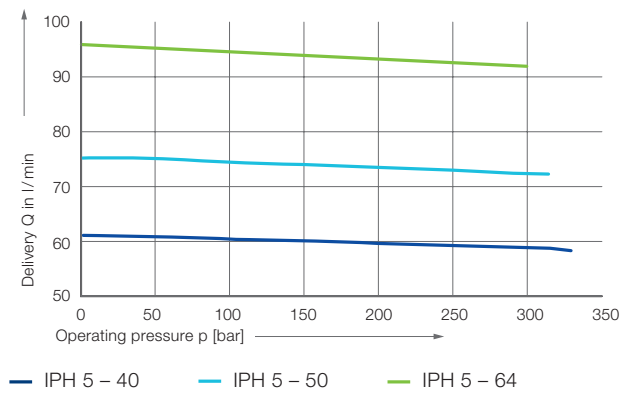

IPH 5

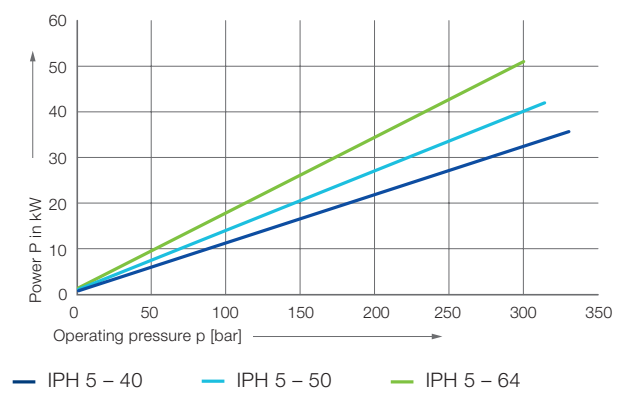

IPH 6

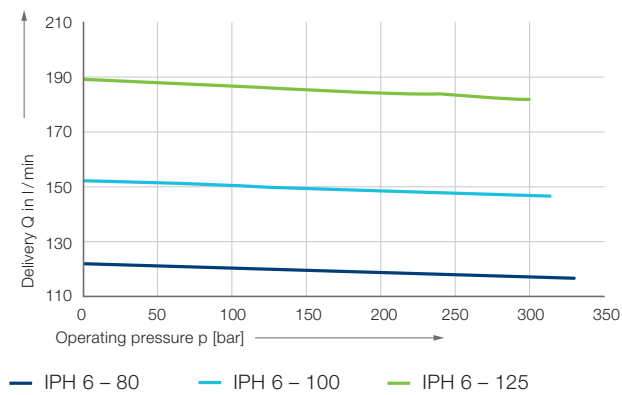

IPH 6

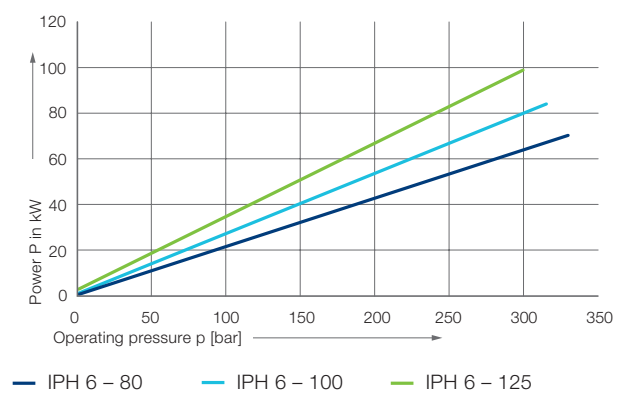

Suction and pressure flange according to SAE...

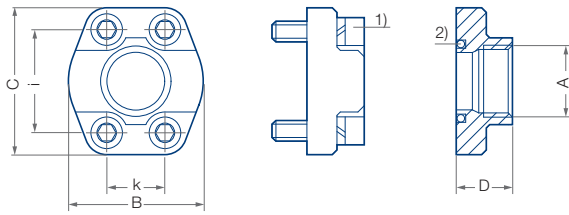

Wrench torque for screws according to ISO 6162

1) Screw EN ISO 4762

2) Round seal ring (O-Ring) ISO-R 1629 NBR

3) Special design. Deviation from SAE J 518 C Code 61

SAE flange no.	A Thread	B [mm]	C [mm]	D [mm]	E ¹⁾ Seal ring	i [mm]	k [mm]	S ²⁾ Thread	Max. pressure [bar]	
SAE J 518 C Code 61	10	G ½	46	54	36	18.66 – 3.53	38.1	17.5	M8	345
	11	G ¾	50	65	36	24.99 – 3.53	47.6	22.3	M10	345
	12	G 1	55	70	38	32.92 – 3.53	52.4	26.2	M10	345
	13	G 1-¼	68	79	41	37.69 – 3.53	58.7	30.2	M10	276
	14 ³⁾	G 1-½	82	98	50	47.22 – 3.53	69.9	35.7	M12	345 ³⁾
	30	G 1-½	78	93	45	47.22 – 3.53	69.9	35.7	M12	207
	15	G 2	90	102	45	56.74 – 3.53	77.8	42.9	M12	207
	16	G 2-½	105	114	50	69.44 – 3.53	88.9	50.8	M12	172
	17	G 3	124	134	50	85.32 – 3.53	106.4	61.9	M16	138
	17/2	G 3-½	136	152	48	98.02 – 3.53	120.7	69.9	M16	35
18	G 4	146	162	48	110.72 – 3.53	130.2	77.8	M16	34	
SAE J 518 C Code 62	50	G ½	46	54	36	18.66 – 3.35	40.5	18.2	M8	414
	51	G ¾	55	71	35	24.99 – 3.53	50.8	23.8	M10	414
	52	G 1	65	81	42	32.92 – 3.53	57.2	27.8	M12	414
	53a	G 1-¼	78	95	45	37.69 – 3.53	66.6	31.8	M14	414
	54	G 1-½	94	112	112	47.22 – 3.53	79.3	36.5	M16	414
	55	G 2	114	134	65	56.75 – 3.53	96.8	44.5	M20	400
	56	G 2-½	152	180	80	69.45 – 3.53	123.8	58.8	M24	400

Multi-flow pumps, pump combinations, pump combinations in order of type and size

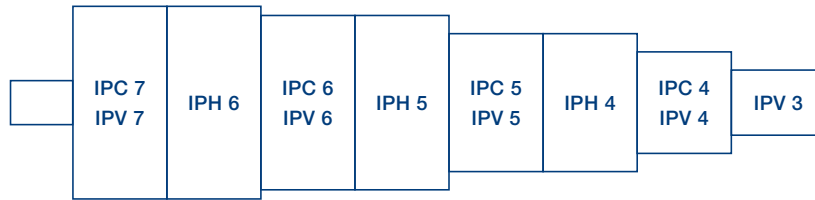

Combinations of IPH pumps

- IPH pumps of identical or different sizes can be combined to form multi-flow pumps.
- All sizes with each displacement
- are available as two or three-flow pumps; four-flow pumps must be designed by Voith.
- The pumps are arranged in increasing order according to size and delivery.

Selection

1. Identify the pressure ranges and then choose the appropriate pump series.
2. Identify the deliveries, and then select the appropriate size(s).
3. Define the sequence of the pumps.
4. Check the torque.
5. Determine the direction of rotation and suction.
6. Specify the mounting flange and shaft end.

Combination of IPH/IP... pumps

- It is possible to combine IPH pumps with other Voith pump series.
- The pumps are arranged by type and size, as shown in the illustration above.
- If identical types or identical sizes follow each other, the pump with the higher pump flow is placed closer to the drive.

Connection, assembly

- As a rule, multi-flow pumps are mounted to the drive using a flange. All information on flange designs and shaft ends is contained in the relevant pump series catalog.
- For further relevant information, such as how to determine the adapter housing, see brochure No. G 1714 (Voith Multi-Flow Pumps).

Designs

Rotation and suction

clockwise (cw)   counterclockwise (ccw)



1

6

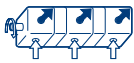

1

6



3

8

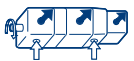

3

8



Special design

4

9

Special design

Mounting flange



0



1



Shaft end



1



0

For designs and dimensions, see catalog of the relevant pump series.

For designs and dimensions, see catalog of the relevant pump series

0 SAE-2-hole-flange

1 SAE-4-hole-flange

Allowed input torques

Size	A [Nm]	B [Nm]
4	450	300
5	800	540
6	1350	800

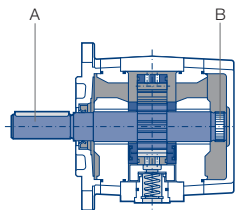

Type code

IPH 5- 50 1 0 1

Shaft end

- 0 Splined gear shaft ANSI B92.1a
- 1 Parallel shaft with keyway

Mounting flange

- 0 SAE-2-hole
- 1 SAE-4-hole

Rotation, Suction port

- 1 Clockwise rotation, suction port pump
- 6 Anti-clockwise rotation, suction port pump
- 4 Clockwise rotation, special design
- 9 Anti-clockwise rotation, special design

Delivery

Size	Delivery		
4	20	25	32
5	40	50	64
6	80	100	125

Size

Type

This is a translated document
Original language: German.
Legally binding language version of the document: German.

90115-IPH-DSH-EN-1907. BDI. All data and information without obligation. Subject to change.

Voith Group
St. Poeltener Str. 43
89522 Heidenheim
Germany

Contact:
Phone +49 7152 992 3
sales-rut@voith.com

www.voith.com/hydraulic-systems



VOITH

Inspiring Technology
for Generations